

Armadura de distribuição	
Armadura	2 N12 Ø8,0 C-325
Nº	1
Armadura	2 N14 Ø8,0 C-325
Nº	1

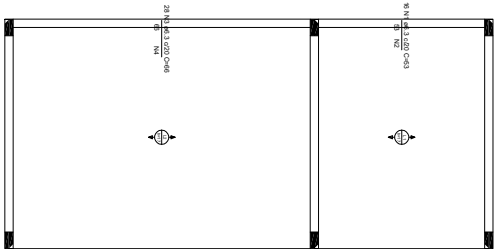

Armadura negativa das lajes do pavimento COBERTURA (Eixo X)
escala 1:50

DETALHE DA ARMADURA SUPERIOR DE CONTINUIDADE DA LAJE E MONTAGEM DA ARMADURA DE DISTRIBUIÇÃO

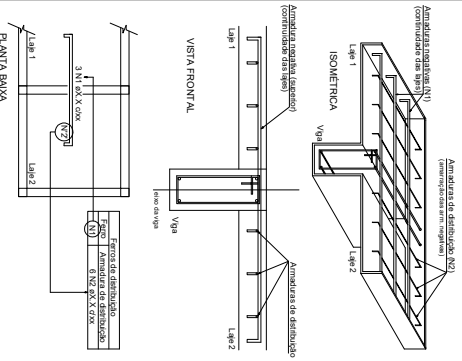

NOTA: ARMADURA DE DISTRIBUIÇÃO DAS CONTINUIDADES DEVE SER INTERLUCRADA E COM TRASPASSE (CASO HAJA BENDAS)

Armadura de distribuição	
Armadura	2 N12 Ø8,0 C-325
Nº	1
Armadura	2 N14 Ø8,0 C-325
Nº	1

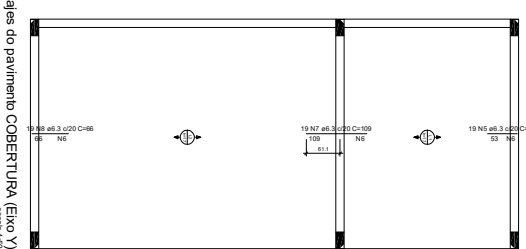

Armadura negativa das lajes do pavimento COBERTURA (Eixo Y)
escala 1:50

DETALHE DA ARMADURA DE BORDO LIVRE DA LAJE

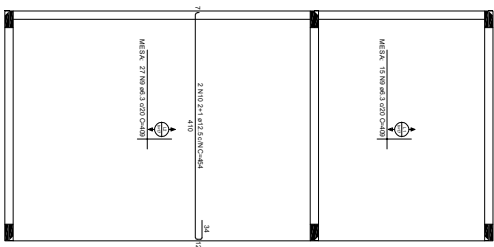

Armadura positiva das lajes do pavimento COBERTURA (Eixo X)
escala 1:50

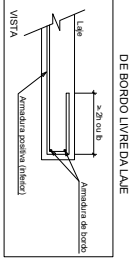

DETALHE DA ARMADURA DE BORDO LIVRE DA LAJE

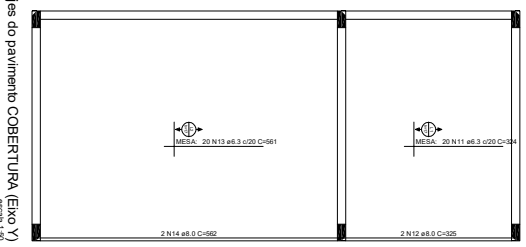

Armadura positiva das lajes do pavimento COBERTURA (Eixo Y)
escala 1:50

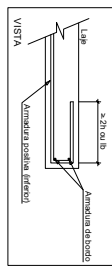

RELAÇÃO DO AÇO									
ELEMENTO	ACO I	N	QDM	QDMT	C/M²	C/30%			
Temporário X	C-325	1	6,3	3,15	44,5	1456			
Temporário Y	C-325	1	6,3	3,15	44,5	1456			
Permanente X	C-325	4	25,2	12,6	178,0	5824			
Permanente Y	C-325	4	25,2	12,6	178,0	5824			
Permanente X	C-325	6	37,8	18,9	267,0	8736			
Permanente Y	C-325	6	37,8	18,9	267,0	8736			
Permanente X	C-325	8	50,4	25,2	356,0	11648			
Permanente Y	C-325	8	50,4	25,2	356,0	11648			
Permanente X	C-325	10	63,0	31,5	445,0	14560			
Permanente Y	C-325	10	63,0	31,5	445,0	14560			
Permanente X	C-325	12	75,6	37,8	534,0	17568			
Permanente Y	C-325	12	75,6	37,8	534,0	17568			
Permanente X	C-325	14	88,2	44,1	623,0	20576			
Permanente Y	C-325	14	88,2	44,1	623,0	20576			
Permanente X	C-325	16	100,8	50,4	712,0	23584			
Permanente Y	C-325	16	100,8	50,4	712,0	23584			
Permanente X	C-325	18	113,4	56,7	801,0	26592			
Permanente Y	C-325	18	113,4	56,7	801,0	26592			
Permanente X	C-325	20	126,0	63,0	890,0	29600			
Permanente Y	C-325	20	126,0	63,0	890,0	29600			
Permanente X	C-325	22	138,6	69,3	979,0	32608			
Permanente Y	C-325	22	138,6	69,3	979,0	32608			
Permanente X	C-325	24	151,2	75,6	1068,0	35616			
Permanente Y	C-325	24	151,2	75,6	1068,0	35616			
Permanente X	C-325	26	163,8	81,9	1157,0	38624			
Permanente Y	C-325	26	163,8	81,9	1157,0	38624			
Permanente X	C-325	28	176,4	88,2	1246,0	41632			
Permanente Y	C-325	28	176,4	88,2	1246,0	41632			
Permanente X	C-325	30	189,0	94,5	1335,0	44640			
Permanente Y	C-325	30	189,0	94,5	1335,0	44640			
Permanente X	C-325	32	201,6	100,8	1424,0	47648			
Permanente Y	C-325	32	201,6	100,8	1424,0	47648			
Permanente X	C-325	34	214,2	107,1	1513,0	50656			
Permanente Y	C-325	34	214,2	107,1	1513,0	50656			
Permanente X	C-325	36	226,8	113,4	1602,0	53664			
Permanente Y	C-325	36	226,8	113,4	1602,0	53664			
Permanente X	C-325	38	239,4	119,7	1691,0	56672			
Permanente Y	C-325	38	239,4	119,7	1691,0	56672			
Permanente X	C-325	40	252,0	126,0	1780,0	59680			
Permanente Y	C-325	40	252,0	126,0	1780,0	59680			
Permanente X	C-325	42	264,6	132,3	1869,0	62688			
Permanente Y	C-325	42	264,6	132,3	1869,0	62688			
Permanente X	C-325	44	277,2	138,6	1958,0	65696			
Permanente Y	C-325	44	277,2	138,6	1958,0	65696			
Permanente X	C-325	46	289,8	144,9	2047,0	68704			
Permanente Y	C-325	46	289,8	144,9	2047,0	68704			
Permanente X	C-325	48	302,4	151,2	2136,0	71712			
Permanente Y	C-325	48	302,4	151,2	2136,0	71712			
Permanente X	C-325	50	315,0	157,5	2225,0	74720			
Permanente Y	C-325	50	315,0	157,5	2225,0	74720			
Permanente X	C-325	52	327,6	163,8	2314,0	77728			
Permanente Y	C-325	52	327,6	163,8	2314,0	77728			
Permanente X	C-325	54	340,2	170,1	2403,0	80736			
Permanente Y	C-325	54	340,2	170,1	2403,0	80736			
Permanente X	C-325	56	352,8	176,4	2492,0	83744			
Permanente Y	C-325	56	352,8	176,4	2492,0	83744			
Permanente X	C-325	58	365,4	182,7	2581,0	86752			
Permanente Y	C-325	58	365,4	182,7	2581,0	86752			
Permanente X	C-325	60	378,0	189,0	2670,0	89760			
Permanente Y	C-325	60	378,0	189,0	2670,0	89760			
Permanente X	C-325	62	390,6	195,3	2759,0	92768			
Permanente Y	C-325	62	390,6	195,3	2759,0	92768			
Permanente X	C-325	64	403,2	201,6	2848,0	95776			
Permanente Y	C-325	64	403,2	201,6	2848,0	95776			
Permanente X	C-325	66	415,8	207,9	2937,0	98784			
Permanente Y	C-325	66	415,8	207,9	2937,0	98784			
Permanente X	C-325	68	428,4	214,2	3026,0	101792			
Permanente Y	C-325	68	428,4	214,2	3026,0	101792			
Permanente X	C-325	70	441,0	220,5	3115,0	104800			
Permanente Y	C-325	70	441,0	220,5	3115,0	104800			
Permanente X	C-325	72	453,6	226,8	3204,0	107808			
Permanente Y	C-325	72	453,6	226,8	3204,0	107808			
Permanente X	C-325	74	466,2	233,1	3293,0	110816			
Permanente Y	C-325	74	466,2	233,1	3293,0	110816			
Permanente X	C-325	76	478,8	239,4	3382,0	113824			
Permanente Y	C-325	76	478,8	239,4	3382,0	113824			
Permanente X	C-325	78	491,4	245,7	3471,0	116832			
Permanente Y	C-325	78	491,4	245,7	3471,0	116832			
Permanente X	C-325	80	504,0	252,0	3560,0	119840			
Permanente Y	C-325	80	504,0	252,0	3560,0	119840			
Permanente X	C-325	82	516,6	258,3	3649,0	122848			
Permanente Y	C-325	82	516,6	258,3	3649,0	122848			
Permanente X	C-325	84	529,2	264,6	3738,0	125856			
Permanente Y	C-325	84	529,2	264,6	3738,0	125856			
Permanente X	C-325	86	541,8	270,9	3827,0	128864			
Permanente Y	C-325	86	541,8	270,9	3827,0	128864			
Permanente X	C-325	88	554,4	277,2	3916,0	131872			
Permanente Y	C-325	88	554,4	277,2	3916,0	131872			
Permanente X	C-325	90	567,0	283,5	4005,0	134880			
Permanente Y	C-325	90	567,0	283,5	4005,0	134880			
Permanente X	C-325	92	579,6	289,8	4094,0	137888			
Permanente Y	C-325	92	579,6	289,8	4094,0	137888			
Permanente X	C-325	94	592,2	296,1	4183,0	140896			
Permanente Y	C-325	94	592,2	296,1	4183,0	140896			
Permanente X	C-325	96	604,8	302,4	4272,0	143904			
Permanente Y	C-325	96	604,8	302,4	4272,0	143904			
Permanente X	C-325	98	617,4	308,7	4361,0	146912			
Permanente Y	C-325	98	617,4	308,7	4361,0	146912			
Permanente X	C-325	100	630,0	315,0	4450,0	149920			
Permanente Y	C-325	100	630,0	315,0	4450,0	149920			
Permanente X	C-325	102	642,6	321,3	4539,0	152928			
Permanente Y	C-325	102	642,6	321,3	4539,0	152928			
Permanente X	C-325	104	655,2	327,6	4628,0	155936			
Permanente Y	C-325	104	655,2	327,6	4628,0	155936			
Permanente X	C-325	106	667,8	333,9	4717,0	158944			
Permanente Y	C-325	106	667,8	333,9	4717,0	158944			
Permanente X	C-325	108	680,4	340,2	4806,0	161952			
Permanente Y	C-325	108	680,4	340,2	4806,0	161952			
Permanente X	C-325	110	693,0	346,5	4895,0	164960			
Permanente Y	C-325	110	693,0	346,5	4895,0	164960			
Permanente X	C-325	112	705,6	352,8	4984,0	167968			
Permanente Y	C-325	112	705,6	352,8	4984,0	167968			
Permanente X	C-325	114	718,2	359,1	5073,0	170976			
Permanente Y	C-325	114	718,2	359,1	5073,0	170976			
Permanente X	C-325	116	730,8	365,4	5162,0	173984			
Permanente Y	C-325	116	730,8	365,4	5162,0	173984			
Permanente X	C-325	118	743,4	371,7	5251,0	176992			
Permanente Y	C-325	118	743,4	371,7	5251,0	176992			
Permanente X	C-325	120	756,0	378,0	5340,0	180000			
Permanente Y	C-325	120	756,0	378,0	5340,0	180000			
Permanente X	C-325	122	768,6	384,3	5429,0	183008			
Permanente Y	C-325	122	768,6	384,3	5429,0	183008			
Permanente X	C-325	124	781,2	390,6	5518,0	186016			
Permanente Y	C-325	124	781,2	390,6	5518,0	186016			
Permanente X	C-325	126	793,8	396,9	5607,0	189024			
Permanente Y	C-325	126	793,8	396,9	5607,0	189024			
Permanente X	C-325	128	806,4	403,2	5696,0	192032			
Permanente Y	C-325	128	806,4	403,2	5696,0	192032			
Permanente X	C-325	130	819,0	409,5	5785,0	195040			
Permanente Y	C-325	130	819,0	409,5	5785,0	195040			
Permanente X	C-325	132	831,6	415,8	5874,0	198048			
Permanente Y	C-325	132	831,6	415,8	5874,0	198048			
Permanente X	C-325	134	844,2	422,1	5963,0	201056			
Permanente Y	C-325	134	844,2	422,1	5963,0	201056			
Permanente X	C-325	136	856,8	428,4	6052,0	204064			
Permanente Y	C-325	136	856,8	428,4	6052,0	204064			
Permanente X	C-325	138	869,4	434,7	6141,0	207072			
Permanente Y	C-325	138	869,4	434,7	6141,0	207072			
Permanente X	C-325	140	882,0	441,0	6230,0	210080			
Permanente Y	C-325	140	882,0	441,0	6230,0	210080			
Permanente X	C-325	142	894,6	447,3	6319,0	213088			
Permanente Y	C-325	142	894,6	447,3	6319,0	213088			
Permanente X	C-325	144	907,2	453,6	6408,0	216096			
Permanente Y	C-325	144	907,2	453,6	6408,0	216096			
Permanente X	C-325	146	919,8	459,9	6497,0	219104			
Permanente Y	C-325	146	919,8	459,9	6497,0	219104			
Permanente X	C-325	148	932,4	466,2	6586,0	222112			
Permanente Y	C-325	148	932,4	466,2	6586,0	222112			
Permanente X	C-325	150	945,0	472,5	6675,0	225120			
Permanente Y	C-325	150	945,0	472,5	6675,0	225120			
Permanente X	C-325	152	957,6	478,8	6764,0	228128			
Permanente Y	C-325	152	957,6	478,8	6764,0	228128			
Permanente X	C-325	154	970,2	485,1	6853,0	231136			
Permanente Y	C-325	154	970,2	485,1	6853,0	231136			
Permanente X	C-325	156	982,8	491,4	6942,0	234144			