



P R E F E I T U R A
MANGA-MG



MEMORIAL DESCRITIVO

Empreendimento: Sinalização Viária Horizontal e Vertical .

Finalidade: Definir normas e critérios para execução da Sinalização Viária

Interessado: Prefeitura de Manga

Manga/MG, 15 de Abril de 2021



Status: Implementar
 Dimensões: 2,132 x 1,477 m
 Chapa: Aço 16
 Película fundo: IV
 Película elementos: IV



Tabela de cotas (mm):

| a | b | c | d | e | f | g | i | l | m | o |
|-----|------|----|-----|-----|------|-----|------|------|-----|----|
| 230 | 1612 | 94 | 175 | 188 | 1333 | 635 | 1034 | 1199 | 278 | 59 |

| r |
|-----|
| 125 |

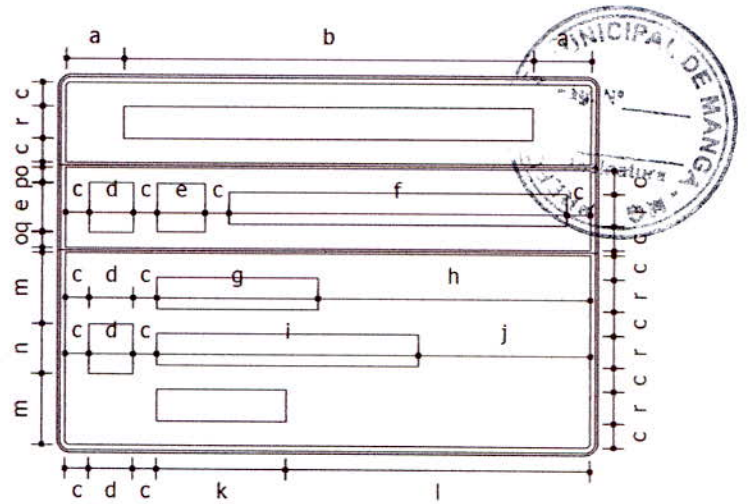

Fundo: Azul
 Tarja: Branco
 Borda: Azul



Fundo: Laranja
 Tarja: Preto
 Borda: Laranja



Fundo: Verde
 Tarja: Branco
 Borda: Verde

Seta: Tipo S1 / Cor: Branco

Símbolo: TNA-07

Seta: Tipo S1 / Cor: Branco

Contornos (mm)

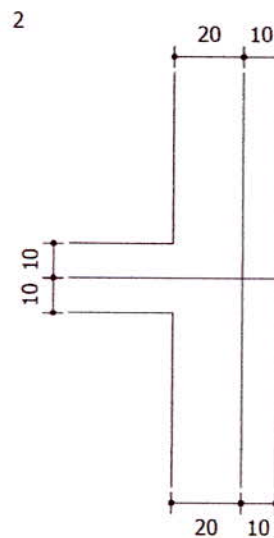
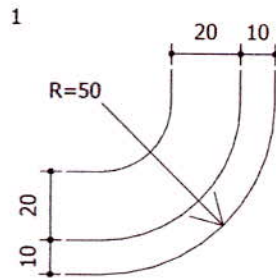

Handwritten signature and notes in blue ink.



Status: Implementar
 Dimensões: 1,725 x 0,592 m
 Chapa: Aço 16
 Película fundo: IV
 Película elementos: IV

Tabela de cotas (mm):

| a | b | c | f | i |
|----|-----|------|-----|-----|
| 94 | 175 | 1208 | 169 | 125 |

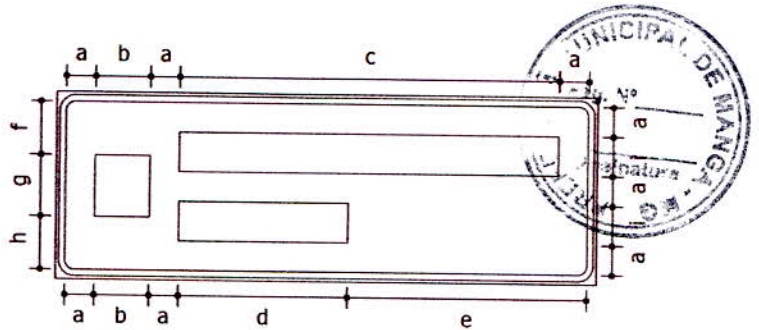

Fundo: Verde
 Tarja: Branco
 Borda: Verde

Seta: Tipo S1 / Cor: Branco

Contornos (mm)

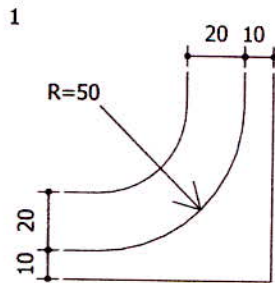

Handwritten signature
 MUNICÍPIO DE MANGA
 SECRETARIA DE OBRAS
 ENGENHEIRO CIVIL

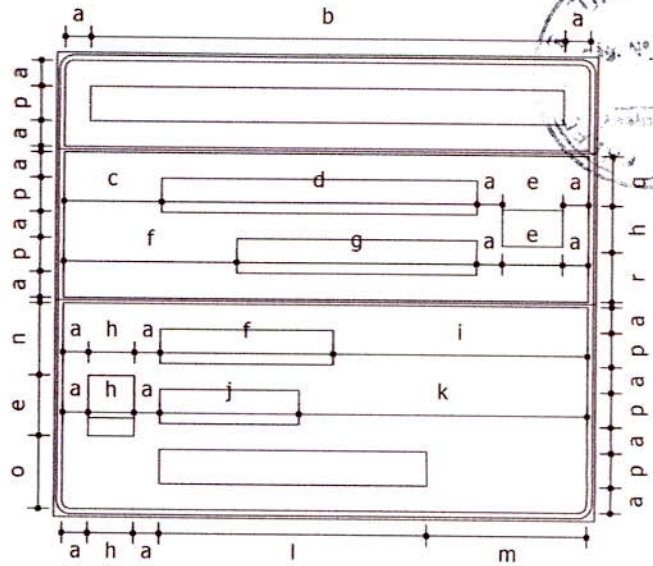
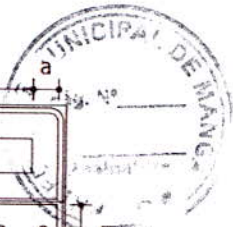

Status: Implementar
 Dimensões: 1,985 x 1,696 m
 Chapa: Aço 16
 Película fundo: IV
 Película elementos: IV

Tabela de cotas (mm):

| a | c | d | e | f | h | k | l | m | n | o | p |
|----|-----|------|-----|-----|-----|------|-----|-----|-----|-----|-----|
| 94 | 358 | 1159 | 220 | 635 | 169 | 1058 | 982 | 586 | 265 | 266 | 125 |

| q | r |
|-----|-----|
| 182 | 181 |

Av. Montalvânia

Fundo: Azul
 Tarja: Branco
 Borda: Azul

**Rodoviária
 Januária** →

Fundo: Verde
 Tarja: Branco
 Borda: Verde

↑
**Centro
 Balsa
 Prefeitura**

Fundo: Verde
 Tarja: Branco
 Borda: Verde

Seta: Tipo 1 / Cor: Branco

Seta: Tipo 1 / Cor: Branco

Contornos (mm)

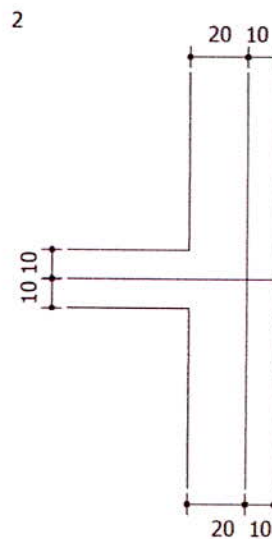
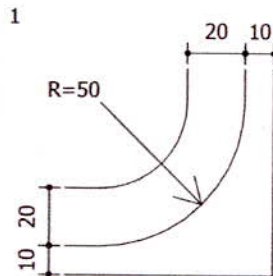

Diego Tavares
 DIEGO TAVARES
 ENGENHEIRO CIVIL
 CREA 10.000.000/000000-00

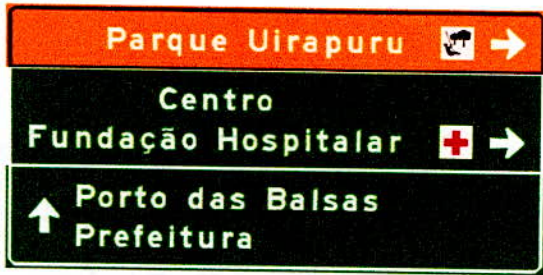

Status: Implementar
 Dimensões: 3,037 x 1,477 m
 Chapa: Aço 16
 Película fundo: IV
 Película elementos: IV

Tabela de cotas (mm):

| | | | | | | | | | | | | |
|-----|------|----|-----|-----|-----|------|------|-----|------|-----|-----|-----|
| a | b | c | d | f | g | h | i | j | k | l | m | o |
| 535 | 1777 | 94 | 188 | 823 | 760 | 1394 | 2218 | 175 | 1700 | 914 | 982 | 169 |

| | | | |
|-----|----|-----|---|
| q | r | u | v |
| 125 | 62 | 281 | 7 |

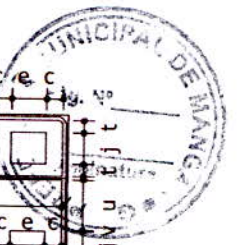
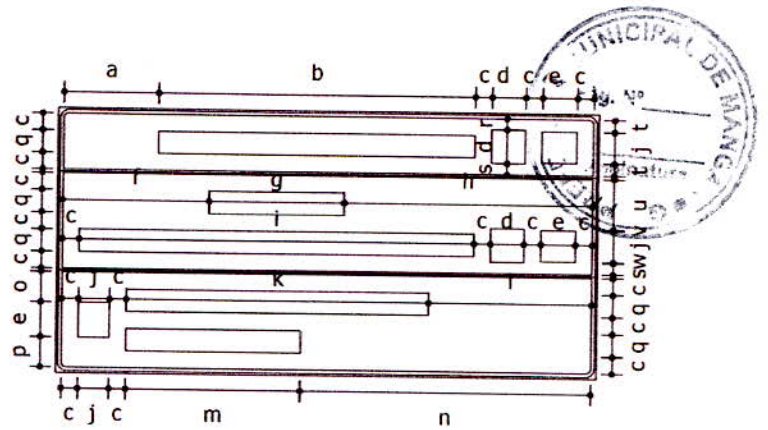

Fundo: Laranja
 Tarja: Preto
 Borda: Laranja

Seta: Tipo S1 / Cor: Branco

Símbolo: 004c



Fundo: Verde
 Tarja: Branco
 Borda: Verde

Símbolo: S-5

Seta: Tipo S1 / Cor: Branco



Fundo: Verde
 Tarja: Branco
 Borda: Verde

Seta: Tipo S1 / Cor: Branco

Contornos (mm)

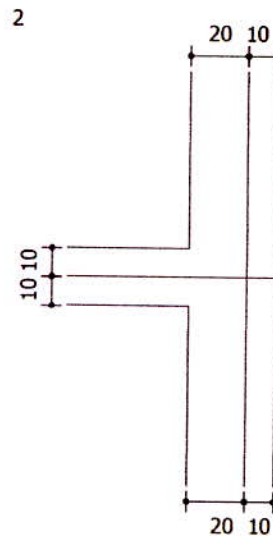
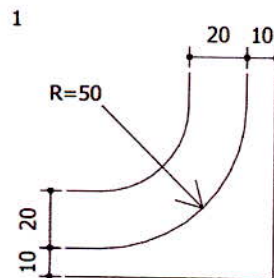

Handwritten signature: Ruy Laran
 Engenheiro Civil
 CREA 14.001/2014 - PA



Status: Implementar
 Dimensões: 2,1 x 1,696 m
 Chapa: Aço 16
 Película fundo: IV
 Película elementos: IV

Tabela de cotas (mm):

| a | b | d | e | h | i | k | m | p |
|-----|------|-----|----|------|-----|-----|-----|-----|
| 214 | 1612 | 893 | 94 | 1055 | 635 | 226 | 583 | 175 |

| q | r | s | t |
|------|-----|------|-----|
| demo | 125 | demo | 295 |

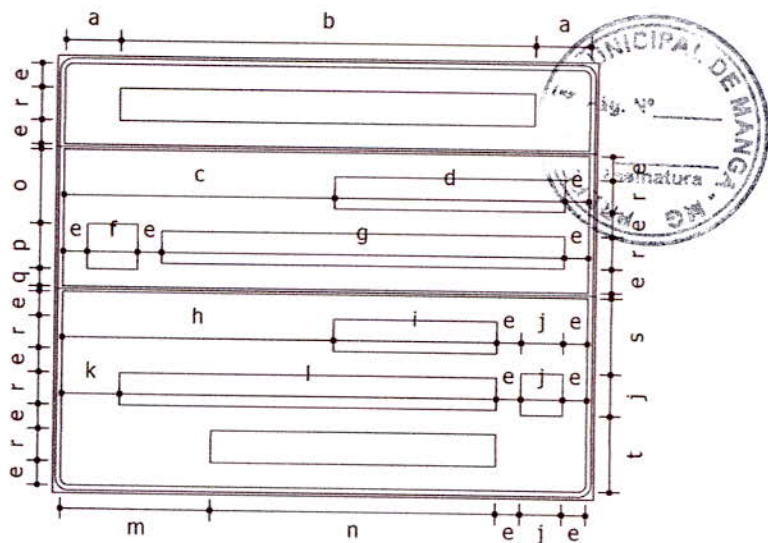

Fundo: Azul
 Tarja: Branco
 Borda: Azul



Fundo: Verde
 Tarja: Branco
 Borda: Verde



Fundo: Verde
 Tarja: Branco
 Borda: Verde

Seta: Tipo S1 / Cor: Branco

Seta: Tipo S1 / Cor: Branco

Contornos (mm)

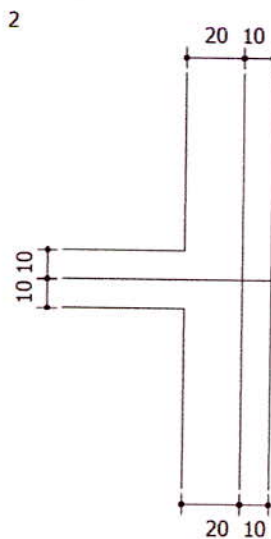
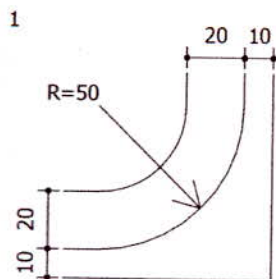

Handwritten signature and stamp:
 MUNICÍPIO DE MANGA
 SECRETARIA DE URBANISMO E OBRAS
 DATA: 10/05/2017

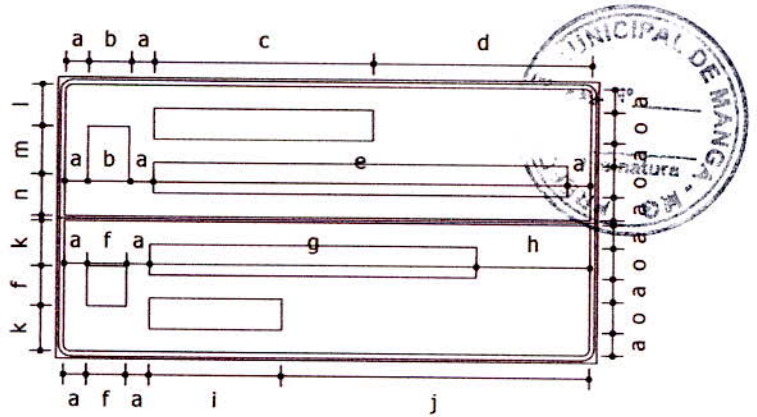
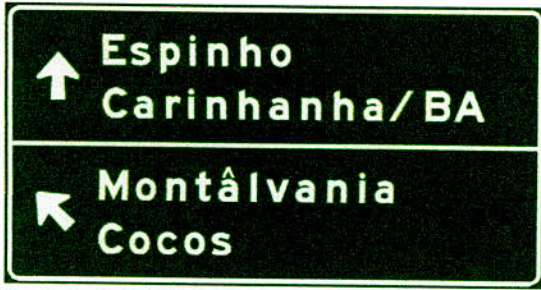

Status: Implementar
 Dimensões: 2,205 x 1,144 m
 Chapa: Aço 16
 Película fundo: IV
 Película elementos: IV

Tabela de cotas (mm):

| a | b | c | d | e | g | j | k | l | o |
|----|-----|-----|-----|------|------|------|-----|-----|-----|
| 94 | 175 | 893 | 889 | 1688 | 1333 | 1255 | 185 | 169 | 125 |



Fundo: Verde
 Tarja: Branco
 Borda: Verde



Fundo: Verde
 Tarja: Branco
 Borda: Verde

Seta: Tipo S1 / Cor: Branco

Seta: Tipo S1 / Cor: Branco

Contornos (mm)

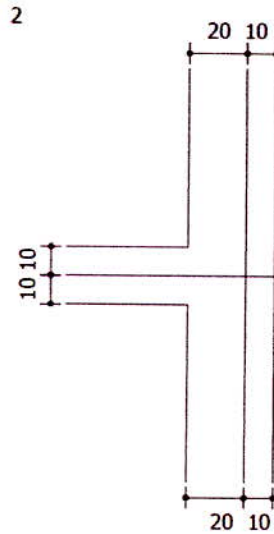
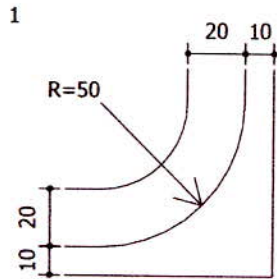

Handwritten signature: Deep Card



Status: Implementar
 Dimensões: 2,482 x 0,958 m
 Chapa: Aço 16
 Película fundo: IV
 Película elementos: IV

Tabela de cotas (mm):

| a | c | f | g | h |
|-----|------|------|------|-----|
| 112 | 1451 | 1343 | 1876 | 332 |

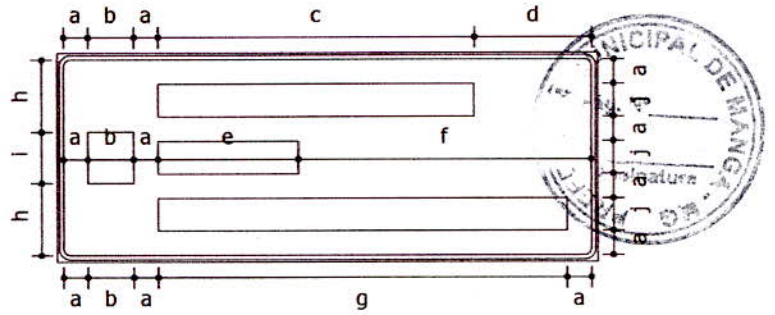

Fundo: Verde
 Tarja: Branco
 Borda: Verde

Seta: Tipo S1 / Cor: Branco

Contornos (mm)

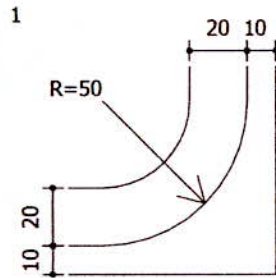
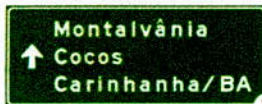

Handwritten signature
 DEPT. TAVARES
 ENGENHEIRO CIVIL



Status: Implementar
 Dimensões: 2,204 x 0,706 m
 Chapa: Aço 16
 Película fundo: IV
 Película elementos: IV

Tabela de cotas (mm):

| a | c | d | e | f | i | j | l |
|----|------|-----|-----|-----|----|----|-----|
| 94 | 1700 | 446 | 175 | 982 | 76 | 59 | 125 |

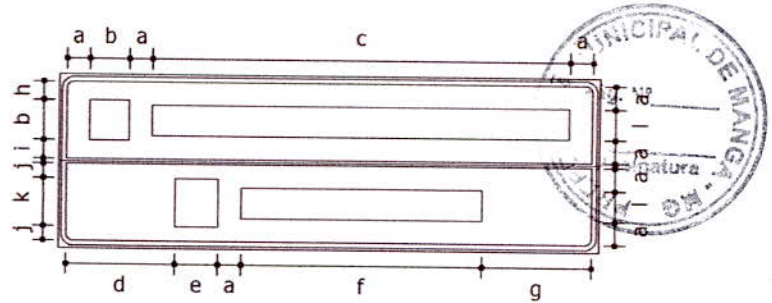

Fundo: Azul
 Tarja: Branco
 Borda: Azul



Fundo: Verde
 Tarja: Branco
 Borda: Verde

Seta: Tipo S1 / Cor: Branco

Seta: Tipo S1 / Cor: Branco

Contornos (mm)

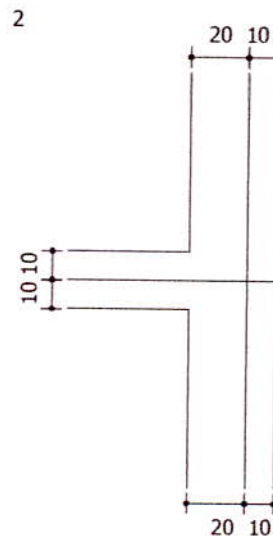
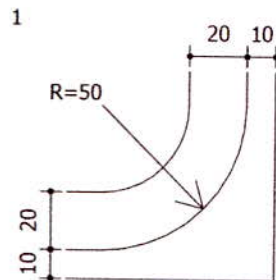

Handwritten signature
 TAVAR
 20 DE ABRIL DE 2011



Status: Implementar
 Dimensões: 2,574 x 1,258 m
 Chapa: Aço 16
 Película fundo: IV
 Película elementos: IV

Tabela de cotas (mm):

| b | c | d | e | f | g | h | j | k | l | m | n | o |
|-----|-----|----|-----|------|------|------|-----|------|----|-----|-----|-----|
| 635 | 940 | 94 | 175 | 2057 | 1097 | 1034 | 269 | 1862 | 59 | 125 | 179 | 178 |

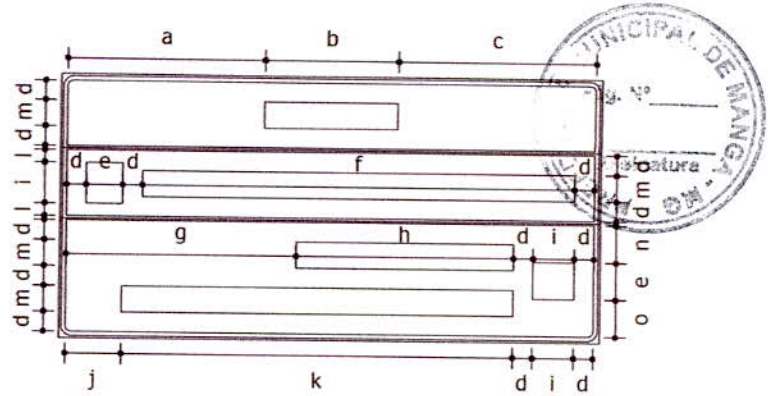

Fundo: Azul
 Tarja: Branco
 Borda: Azul



Fundo: Verde
 Tarja: Branco
 Borda: Verde



Fundo: Verde
 Tarja: Branco
 Borda: Verde

Seta: Tipo S1 / Cor: Branco

Seta: Tipo S1 / Cor: Branco

Contornos (mm)

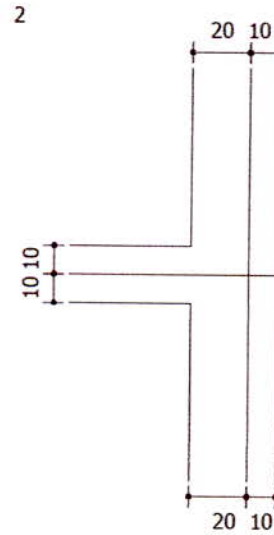
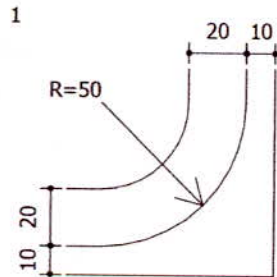

Diego Tavares
 DIEGO TAVARES
 ENGENHEIRO CIVIL
 CREA 3.127/04-0001/2014



Status: Implementar
 Dimensões: 1,87 x 1,03 m
 Chapa: Aço 16
 Película fundo: IV
 Película elementos: IV

Tabela de cotas (mm):

| a | c | e | g | h | i | j | k |
|----|-----|------|-----|-----|-----|-----|-----|
| 94 | 635 | 1333 | 887 | 398 | 175 | 397 | 125 |

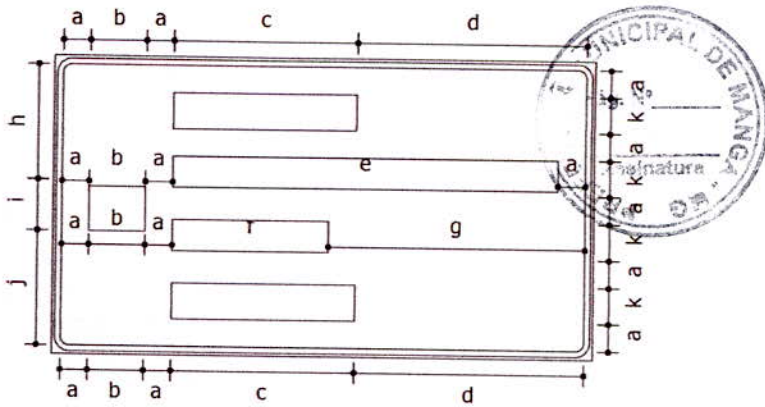

Fundo: Verde
 Tarja: Branco
 Borda: Verde
 Seta: Tipo S1 / Cor: Branco

Contornos (mm)

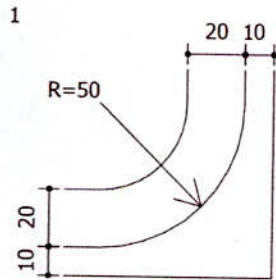

[Handwritten Signature]
 ARTECI 17.249/2005
 ENGENHEIRO CIVIL
 CREA: 01/13.094/00-1

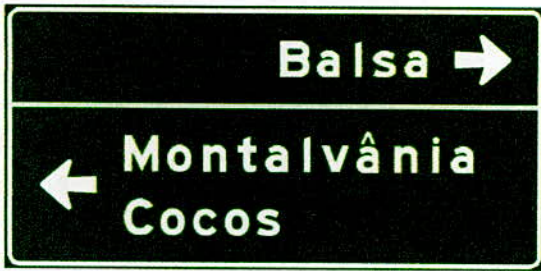

Status: Implementar
 Dimensões: 2,231 x 1,09 m
 Chapa: Aço 16
 Película fundo: IV
 Película elementos: IV

Tabela de cotas (mm):

| c | e | k |
|-----|------|----|
| 112 | 1601 | 82 |

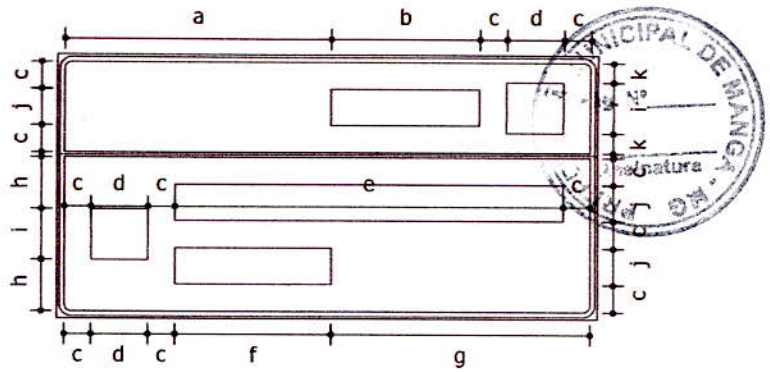

Fundo: Verde
 Tarja: Branco
 Borda: Verde

Seta: Tipo S1 / Cor: Branco



Fundo: Verde
 Tarja: Branco
 Borda: Verde

Seta: Tipo S1 / Cor: Branco

Contornos (mm)

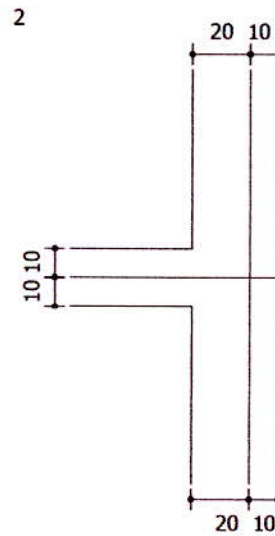
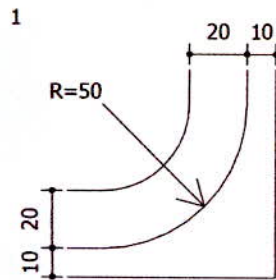

prop tower
 ENG.º TAVAR
 ENGENHEIRO CIVIL



Status: Implementar
 Dimensões: 2,912 x 1,372 m
 Chapa: Aço 16
 Película fundo: IA (Edital Br Legal)
 Película elementos: IA (Edital Br Legal)

Tabela de cotas (mm):

| b | c | d | e | g | h | j | k | l | m | o | p |
|------|-----|-----|----|-----|-----|------|-----|------|-----|----|-----|
| 2324 | 277 | 175 | 94 | 278 | 157 | 2248 | 158 | 2093 | 188 | 59 | 125 |

| q |
|----|
| 62 |

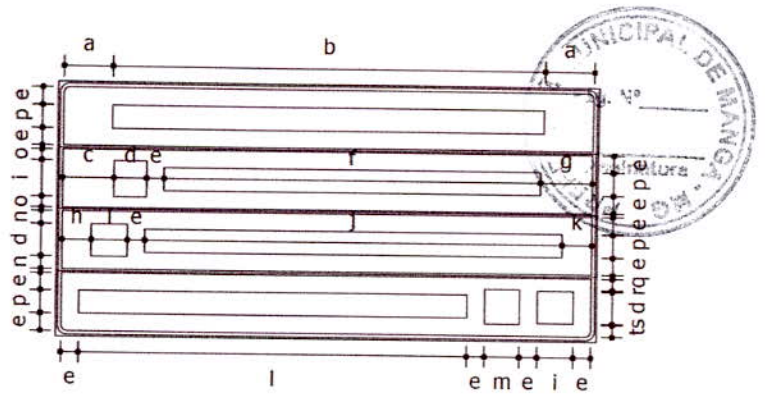

Rua Almirante Barroso

Fundo: Azul
 Tarja: Branco
 Borda: Azul

Terminal Rodoviário

Fundo: Verde
 Tarja: Branco
 Borda: Verde

Estádio Mario Barbosa

Fundo: Verde
 Tarja: Branco
 Borda: Verde

Fundação Hospitalar

Seta: Tipo S1 / Cor: Branco

Seta: Tipo S1 / Cor: Branco

Fundo: Verde
 Tarja: Branco
 Borda: Verde

Símbolo: SAU-10

Seta: Tipo S1 / Cor: Branco

Contornos (mm)

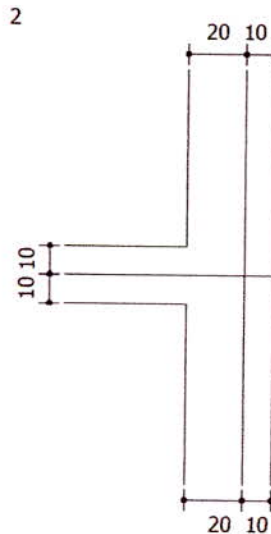
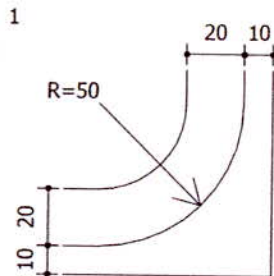

Handwritten signature and notes in blue ink.



Status: Implementar
 Dimensões: 2,733 x 1,169 m

Tabela de cotas (mm):

| b | c | e | f | g | h | i | j | k | m | o |
|------|----|-----|------|------|------|------|------|-----|----|-----|
| 1238 | 94 | 175 | 2216 | 1058 | 1252 | 1132 | 1178 | 278 | 82 | 125 |

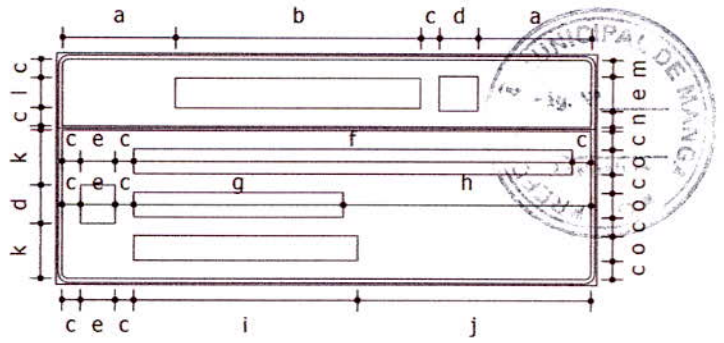

Fundo: Azul
 Tarja: Branco
 Borda: Azul



Fundo: Verde
 Tarja: Branco
 Borda: Verde

Seta: Tipo S1 / Cor: Branco

Seta: Tipo S1 / Cor: Branco

Contornos (mm)

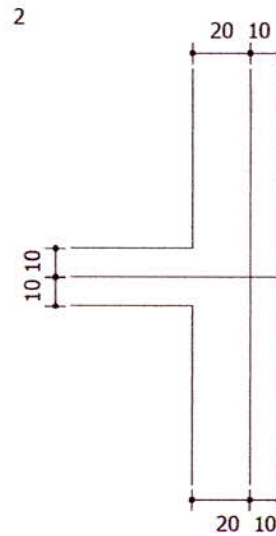
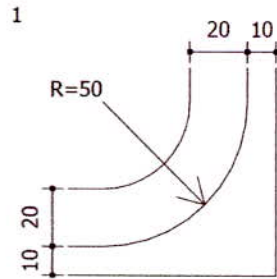

Diego Tavares
 DIEGO TAVARES
 ENGENHEIRO CIVIL
 CREA 100000000-0

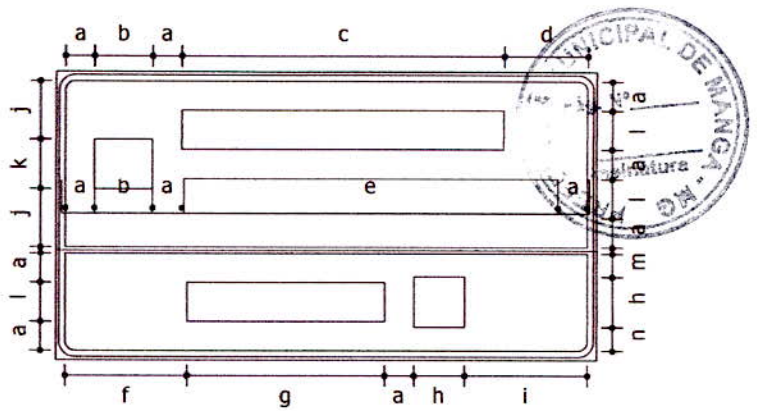

Status: Implementar
 Dimensões: 1,736 x 0,925 m
 Chapa: Aço 16
 Película fundo: IA (Edital Br Legal)
 Película elementos: IA (Edital Br Legal)

Tabela de cotas (mm):

| a | c | d | e | f | g | j | k | l | n |
|----|------|-----|------|-----|-----|-----|-----|-----|----|
| 94 | 1034 | 268 | 1208 | 392 | 635 | 187 | 158 | 125 | 76 |



Fundo: Verde
 Tarja: Branco
 Borda: Verde



Fundo: Verde
 Tarja: Branco
 Borda: Verde

Seta: Tipo S1 / Cor: Branco

Seta: Tipo S1 / Cor: Branco

Contornos (mm)

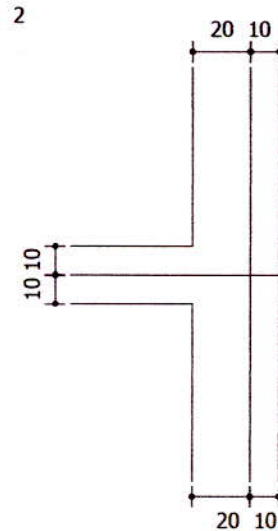
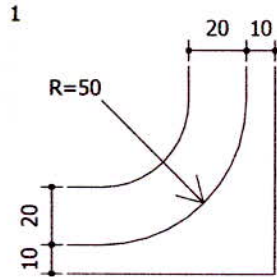

Diego Torres
 INGENIERO CIVIL



Status: Implementar
 Dimensões: 1,745 x 1,144 m
 Chapa: Aço 16
 Película fundo: IV
 Película elementos: IV

Tabela de cotas (mm):

| a | c | f | g | j | k | l | m |
|----|------|-----|-----|-----|-----|-----|-----|
| 94 | 1208 | 542 | 760 | 179 | 175 | 178 | 125 |

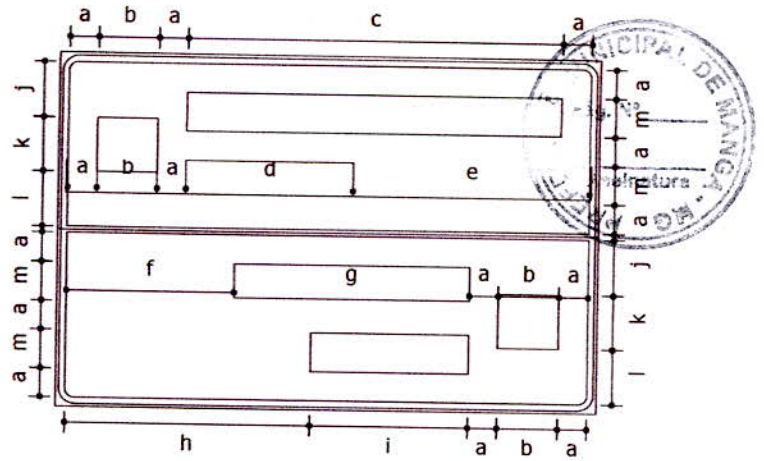

Fundo: Verde
 Tarja: Branco
 Borda: Verde

Seta: Tipo S1 / Cor: Branco



Fundo: Verde
 Tarja: Branco
 Borda: Verde

Seta: Tipo S1 / Cor: Branco

Contornos (mm)

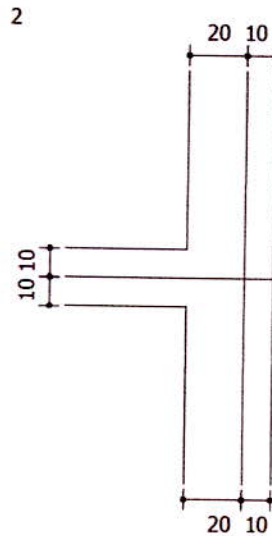
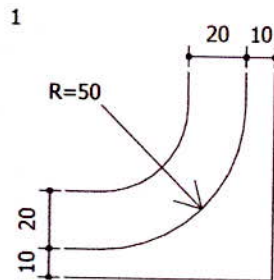

Handwritten signature
 28/07/2024
 08:15:00

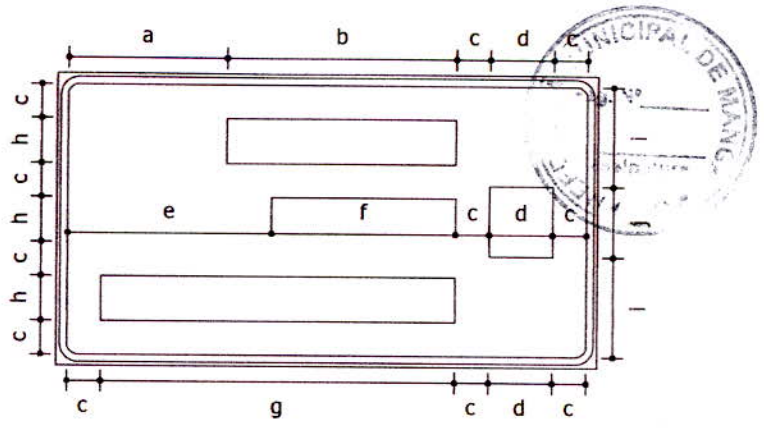

Status: Implementar
 Dimensões: 1,499 x 0,811 m
 Chapa: Aço 16
 Película fundo: IV
 Película elementos: IV

Tabela de cotas (mm):

| b | c | d | e | g | h | i |
|-----|----|-----|-----|-----|-----|-----|
| 635 | 94 | 175 | 566 | 982 | 125 | 278 |



Fundo: Verde
 Tarja: Branco
 Borda: Verde
 Seta: Tipo S1 / Cor: Branco

Contornos (mm)

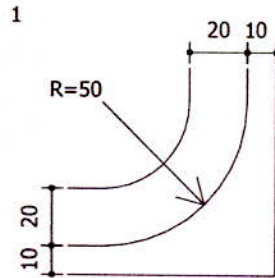

Handwritten signature and stamp.

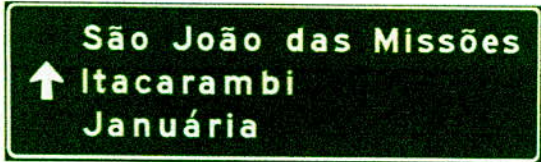

Status: Implementar
 Dimensões: 2,733 x 0,811 m
 Chapa: Aço 16
 Película fundo: IV
 Película elementos: IV



Tabela de cotas (mm):

| a | b | c | d | e | f | g | h | j |
|----|-----|------|------|------|------|------|-----|-----|
| 94 | 175 | 2216 | 1183 | 1127 | 1007 | 1303 | 278 | 125 |

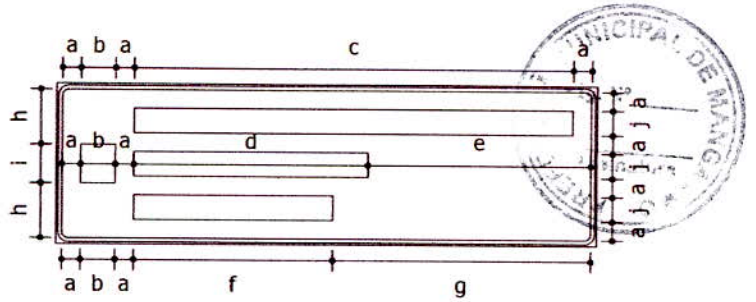
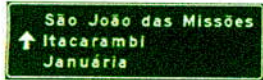

Fundo: Verde
 Tarja: Branco
 Borda: Verde

Seta: Tipo S1 / Cor: Branco

Contornos (mm)

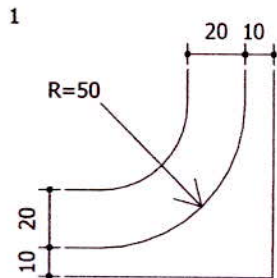

Handwritten signature in blue ink.



| Placa | Detalhes | Materiais |
|-------|---|---|
| | Placa 15 Status: Implementar Dimensões: 2,204 x 0,706 m | Chapa: Aço 16 1,556 m ² Película fundo: IV Azul: 0,778 m ² Verde: 0,778 m ² Película elementos: IV Branco: 0,443 m ² Suporte: Braço Projetado |
| | Placa 9 Status: Implementar Dimensões: 2,574 x 1,258 m | Chapa: Aço 16 3,238 m ² Película fundo: IV Azul: 0,909 m ² Verde: 2,329 m ² Película elementos: IV Branco: 0,783 m ² Suporte: Braço Projetado |
| | Placa 33 Status: Implementar Dimensões: 1,87 x 1,03 m | Chapa: Aço 16 1,926 m ² Película fundo: IV Verde: 1,926 m ² Película elementos: IV Branco: 0,412 m ² Suporte: Braço Projetado |
| | Placa 34 Status: Implementar Dimensões: 2,231 x 1,09 m | Chapa: Aço 16 2,432 m ² Película fundo: IV Verde: 2,432 m ² Película elementos: IV Branco: 0,568 m ² Suporte: Duplo |
| | Placa 17 Status: Implementar Dimensões: 2,912 x 1,372 m | Chapa: Aço 16 3,995 m ² Película fundo: IA (Edital Br Legal) Azul: 1,028 m ² Verde: 2,967 m ² Película elementos: IA (Edital Br Legal) Branco: 1,152 m ² (não inclui símbolos) Suporte: Duplo |
| | Placa 35 Status: Implementar Dimensões: 2,733 x 1,169 m | |
| | Placa 21 Status: Implementar Dimensões: 1,736 x 0,925 m | Chapa: Aço 16 1,606 m ² Película fundo: IA (Edital Br Legal) Verde: 1,606 m ² Película elementos: IA (Edital Br Legal) Branco: 0,448 m ² Suporte: Duplo |
| | Placa 32 Status: Implementar Dimensões: 1,745 x 1,144 m | Chapa: Aço 16 1,996 m ² Película fundo: IV Verde: 1,996 m ² Película elementos: IV Branco: 0,48 m ² Suporte: Duplo |

Handwritten signature



Placa

Detalhes

Materiais



Placa 1
Status: Implementar
Dimensões: 2,132 x 1,477 m

Chapa: Aço 16
3,149 m²
Película fundo: IV
Azul: 0,753 m²
Laranja: 0,71 m²
Verde: 1,686 m²
Película elementos: IV
Branco: 0,676 m²
Preto: 0,056 m²
(não inclui símbolos)
Suporte: Braço Projetado



Placa 2
Status: Implementar
Dimensões: 1,725 x 0,592 m

Chapa: Aço 16
1,021 m²
Película fundo: IV
Verde: 1,021 m²
Película elementos: IV
Branco: 0,282 m²
Suporte: Duplo



Placa 3
Status: Implementar
Dimensões: 1,985 x 1,696 m

Chapa: Aço 16
3,367 m²
Película fundo: IV
Azul: 0,701 m²
Verde: 2,666 m²
Película elementos: IV
Branco: 0,79 m²
Suporte: Braço Projetado



Placa 7
Status: Implementar
Dimensões: 2,1 x 1,696 m

Chapa: Aço 16
3,562 m²
Película fundo: IV
Azul: 0,741 m²
Verde: 2,82 m²
Película elementos: IV
Branco: 0,897 m²
Suporte: Braço Projetado



Placa 28
Status: Implementar
Dimensões: 2,205 x 1,144 m

Chapa: Aço 16
2,523 m²
Película fundo: IV
Verde: 2,523 m²
Película elementos: IV
Branco: 0,6 m²
Suporte: Duplo



Placa 13
Status: Implementar
Dimensões: 3,037 x 1,477 m

Chapa: Aço 16
4,486 m²
Película fundo: IV
Laranja: 1,072 m²
Verde: 3,414 m²
Película elementos: IV
Preto: 0,104 m²
Branco: 0,885 m²
(não inclui símbolos)
Suporte: Braço Projetado



Placa 30
Status: Implementar
Dimensões: 2,482 x 0,958 m

Chapa: Aço 16
2,378 m²
Película fundo: IV
Verde: 2,378 m²
Película elementos: IV
Branco: 0,615 m²
Suporte: Duplo

Handwritten signature

Placa

Detalhes

Materiais



Placa 23
Status: Implementar
Dimensões: 1,499 x 0,811 m

Chapa: Aço 16
1,216 m²
Película fundo: IV
Verde: 1,216 m²
Película elementos: IV
Branco: 0,318 m²
Suporte: Braço Projetado

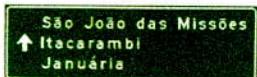

Placa 11
Status: Implementar
Dimensões: 2,733 x 0,811 m

Chapa: Aço 16
2,216 m²
Película fundo: IV
Verde: 2,216 m²
Película elementos: IV
Branco: 0,516 m²
Suporte: Duplo



Diego Tavares
DIEGO TAVARES
ENGENHEIRO CIVIL
CREA-MS 04.550.001/320



Engenheiro
ENGENHEIRO CIVIL
C.R. 01/01/2011



Dyffluoran
MELO TAVARES
ENGENHEIRO CIVIL
C.R.C. 001.201.000.000

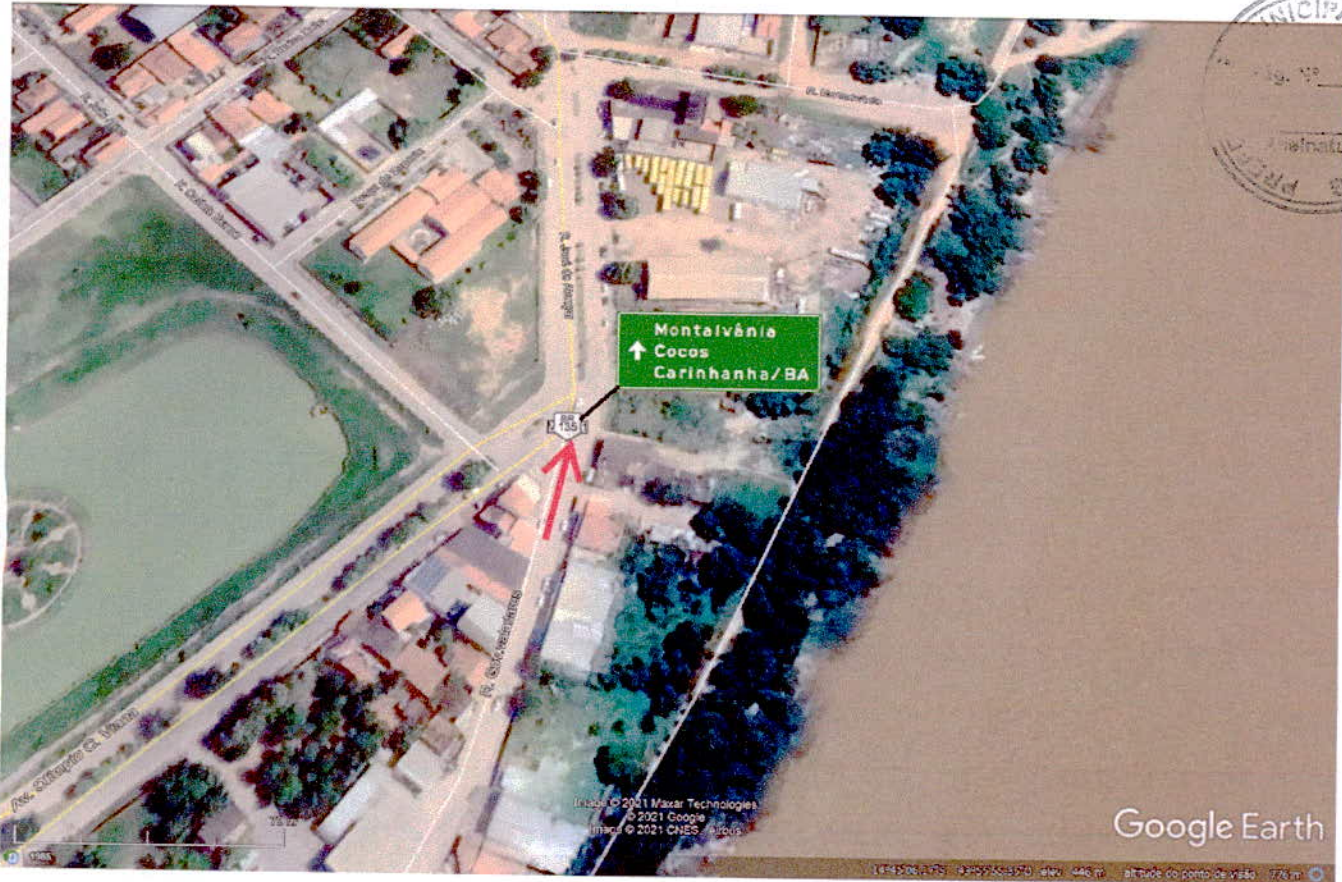

Superior
ENGENHEIRO CIVIL



Diego Tamariz
DIEGO TAMARIZ
 ENGENHEIRO CIVIL
 CREA: 108.978/0-1



Diego Tavares
DIEGO TAVARES
ENGENHEIRO CIVIL
CREA Nº 04.676.010/360



Diego Tavares
DIEGO TAVARES
ENGENHEIRO CIVIL
PARECER Nº 001/2021

210
MANG



dupl. Arquivo